

CENNIK SYSTEMÓW WENTYLACYJNYCH



Oferujemy wysokiej jakości przewody wentylacyjne ze stali ocynkowanej. W swojej ofercie posiadamy także bogaty asortyment akcesoriów, takich jak: czerpnie, wyrzutnie, przepustnice, podstawy dachowe, cokoły, wywiewniki, skrzynki rozprężne i inne. Bez problemu zaoferujemy kompleksowe instalacje wentylacyjne.



Krótki czas realizacji zamówienia i dostawy.

Pełna oferta wentylacji <http://akklimatyzacje.pl/pl/wentylacja/>

www.ak-klimatyzacje.pl
biuro@ak-klimatyzacje.pl

*Dla instalatorów indywidualne warunki handlowe.

Rury spiro

				
Średnica d [mm]	Długość [m]	Obwód [m]	Cena netto PLN	Cena za 1m netto PLN
80	3,0	0,251	44,63	14,87
100	3,0	0,314	48,95	16,31
125	3,0	0,393	62,43	20,81
160	3,0	0,503	79,85	26,61
200	3,0	0,628	99,81	33,27
250	3,0	0,785	138,25	40,08
315	3,0	0,990	172,69	57,56
400	3,0	1,257	226,73	75,57
500	3,0	1,571	364,14	121,38

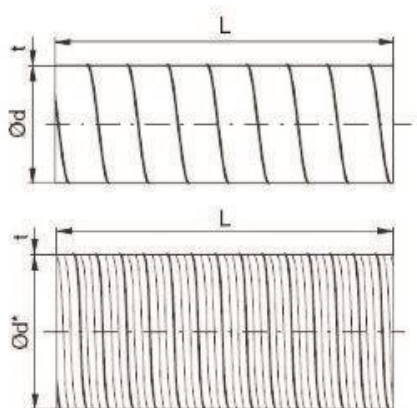

Kolana łęczone

	Bez uszczelki				Z uszczelką			
	B 90°		B 45°		BU 90°		BU 45°	
	Średnica d1 [mm]	Waga m [kg]	Cena netto PLN	Waga m [kg]	Cena netto PLN	Waga m [kg]	Cena netto PLN	Waga m [kg]
80	0,26	23,52	0,17	18,27	0,26	26,57	0,17	22,68
100	0,31	18,62	0,21	15,19	0,31	26,57	0,21	22,68
125	0,48	23,91	0,29	18,03	0,48	32,45	0,29	25,62
160	0,74	35,61	0,48	24,47	0,74	48,29	0,48	35,09
200	1,12	49,99	0,80	31,23	1,12	66,75	0,80	44,16

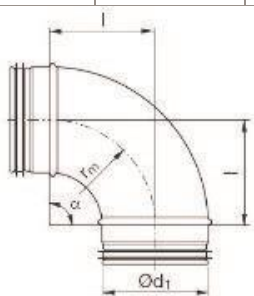

	Bez uszczelki				Z uszczelką			
	BF 90°		BF 45°		BFU 90°		BFU 45°	
	Średnica d1 [mm]	Waga m [kg]	Cena netto PLN	Waga m [kg]	Cena netto PLN	Waga m [kg]	Cena netto PLN	Waga m [kg]
250	1,77	50,49	1,05	37,13	1,77	67,46	1,05	52,33
315	3,00	74,16	1,90	47,70	3,00	94,74	1,90	68,96
400	5,64	121,53	2,96	73,18	5,64	156,82	2,96	91,54
500	8,20	199,32	4,90	133,43	8,20	236,83	4,90	157,96

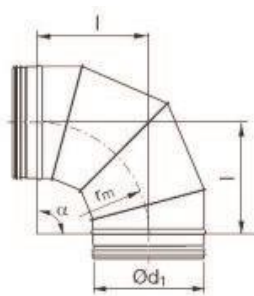

Trójnik prosty

		Bez uszczelki				Z uszczelką			
		TCP				TCPU			
Średnica d1 [mm]	Średnica d3 [mm]	L [mm]	H [mm]	Waga m [kg]	Cena netto PLN	L [mm]	H [mm]	Waga m [kg]	Cena netto PLN
100	80	103	65	0,23	18,73	103	65	0,23	27,62
100	100	130	65	0,32	22,19	130	65	0,32	31,02
125	100	130	78	0,37	21,99	130	78	0,37	31,30
125	125	165	83	0,44	23,49	165	83	0,44	37,64
160	100	130	95	0,46	26,63	130	95	0,46	35,51
160	160	209	105	0,63	39,75	209	105	0,63	49,85
200	100	175	115	0,88	34,16	175	115	0,88	59,03
200	125	215	115	1,02	34,82	215	115	1,02	63,77
200	160	209	125	0,67	40,10	209	125	0,67	58,58
200	200	249	125	1,21	45,74	249	125	1,21	71,03
250	160	256	150	1,58	59,53	256	150	1,58	89,87
250	200	306	150	1,78	63,11	306	150	1,78	110,97
315	200	306	182	2,14	75,50	306	182	2,14	121,37
315	250	350	182	2,59	95,04	350	182	2,59	149,96
315	315	363	182	2,20	129,43	363	182	2,20	161,72
400	250	350	225	3,79	136,37	350	225	3,79	229,40
400	315	415	225	4,42	165,04	415	225	4,42	290,60
400	400	510	225	6,20	203,99	510	225	6,20	219,05
500	315	415	275	5,30	217,20	415	275	5,30	310,23
500	400	510	275	6,34	269,69	510	275	6,34	385,21
500	500	552	290	8,27	338,59	552	290	8,27	483,65

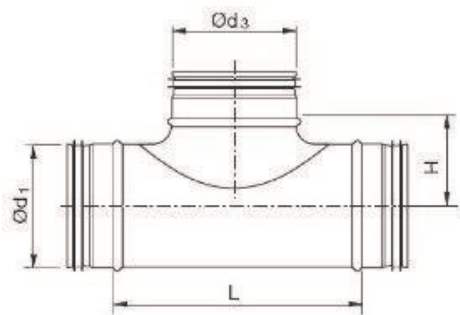



Redukcje

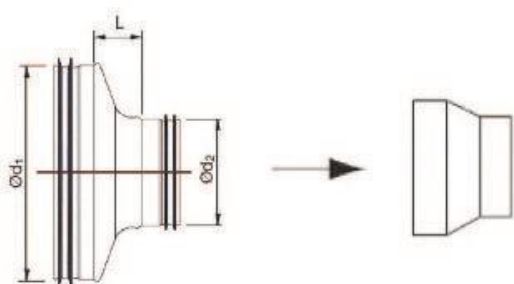

		Z uszczelką			Bez uszczelki		
							
Średnica [mm]	Średnica [mm]	L [mm]	Waga [kg]	Cena netto PLN	L [mm]	Waga [kg]	Cena netto PLN
100	80	26	0,18	12,93	26	0,18	30,32
125	100	27	0,21	13,83	27	0,21	29,25
160	100	46	0,17	16,77	46	0,17	33,66
160	125	35	0,22	15,58	35	0,22	34,11
200	100	46	0,22	28,53	46	0,22	43,96
200	125	55	0,30	28,53	55	0,30	41,76
200	160	39	0,29	22,05	39	0,29	44,10
250	125	70	0,62	50,28	70	0,62	67,63
250	160	60	0,46	29,15	60	0,46	53,37
250	200	42	0,46	28,68	42	0,46	54,10
315	160	91	0,86	51,01	91	0,86	99,97
315	200	74	0,72	51,01	74	0,72	102,47
315	250	50	0,65	43,81	50	0,65	87,62
400	200	118	1,37	100,85	118	1,37	136,75
400	250	94	1,38	73,48	94	1,38	89,98
400	315	54	1,29	77,43	54	1,29	90,14
500	250	128	2,30	130,32	128	2,30	113,42
500	315	95	1,90	121,70	95	1,90	121,40
500	400	68	1,76	118,10	68	1,76	150,97



Sztucer siodłowy



		Bez uszczelki			Z uszczelką		
							
Średnica d1 [mm]	Średnica d2 [mm]	L [mm]	Waga m [kg]	Cena netto PLN	L [mm]	Waga m [kg]	Cena netto PLN
100	80	60	0,14	11,70	60	0,14	19,88
100	100	65	0,18	12,03	65	0,18	21,89
125	80	75	0,13	11,70	75	0,13	19,88
125	100	78	0,18	12,03	78	0,18	21,89
125	125	83	0,25	14,54	83	0,25	25,74
160	100	95	0,18	12,03	95	0,18	21,89
160	125	100	0,18	14,54	100	0,18	25,74
160	160	105	0,26	21,73	105	0,26	34,91
200	100	115	0,19	12,03	115	0,19	21,89
200	125	115	0,25	14,54	115	0,25	25,74
200	160	125	0,27	21,73	125	0,27	34,91
200	200	125	0,39	30,23	125	0,39	46,61
250	100	140	0,18	12,03	140	0,18	21,89
250	125	145	0,23	14,54	145	0,23	25,74
250	160	150	0,24	21,73	150	0,24	34,91
250	200	150	0,47	30,23	150	0,47	46,61
250	250	150	0,80	47,61	150	0,80	59,64
315	100	173	0,12	12,03	173	0,12	21,89
315	125	178	0,23	14,54	178	0,23	25,74
315	160	182	0,24	21,73	182	0,24	34,91
315	200	182	0,46	30,23	182	0,46	46,61
315	250	182	0,71	47,61	182	0,71	59,64
315	315	182	1,22	68,67	182	1,22	85,37
400	160	225	0,24	21,73	225	0,24	34,91
400	200	225	0,44	30,23	225	0,44	46,61
400	250	225	0,65	41,59	225	0,65	59,64
400	315	225	1,03	68,67	225	1,03	78,35
400	400	225	1,87	86,04	225	1,87	106,42
500	160	275	0,25	21,73	275	0,25	37,13
500	200	275	0,42	31,41	275	0,42	51,98
500	250	275	0,67	47,61	275	0,67	59,64
500	315	275	0,93	68,67	275	0,93	85,37
500	400	275	1,75	86,04	275	1,75	106,42
500	500	290	1,87	113,60	290	1,87	121,12

Mufy i nypłe

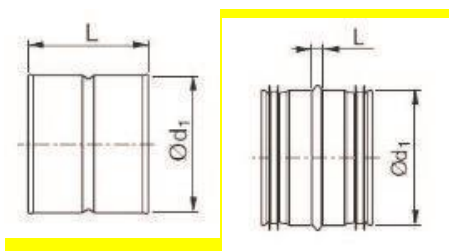
	MUFA			NYPEL		
						
	NP			NPU		
Średnica d1 [mm]	L [mm]	Waga m [kg]	Cena netto PLN	L [mm]	Waga m [kg]	Cena netto PLN
125	8	0,15	6,91	8	0,15	6,33
160	8	0,19	7,94	8	0,19	7,65
200	10	0,30	9,56	10	0,30	9,27
250	10	0,52	11,82	10	0,52	11,82
315	10	0,66	15,35	10	0,66	15,35
400	10	1,10	18,79	10	1,10	18,79
500	10	1,52	36,37	10	1,52	36,37



Zaślepka -dekiel

	Z uszczelka			Bez uszczelki		
						
	EP			ESU		
Średnica d1 [mm]	li [mm]	Waga m [kg]	Cena netto PLN	l [mm]	Waga m [kg]	Cena netto PLN
80	21	0,05	10,81	10	0,08	22,13
100	23	0,09	10,02	10	0,12	22,13
125	20	0,09	10,02	10	0,14	23,14
160	22	0,14	13,37	10	0,24	23,88
200	20	0,19	15,96	10	0,32	29,11
250	26	0,27	21,61	10	0,37	45,52
315	21	0,51	31,90	10	0,80	61,67

400	20	0,76	44,00	12	1,26	91,30
500	20	1,22	75,78	12	2,00	98,60

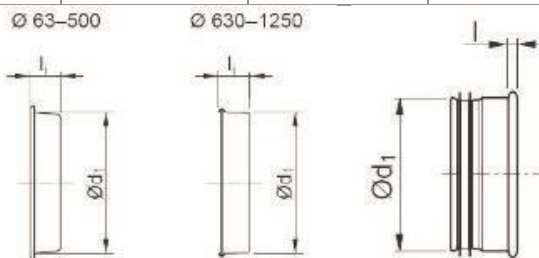

Przepustnice

	Bez uszczelki		Z uszczelką	
	Waga m [kg]	Cena netto PLN	Waga m [kg]	Cena netto PLN
Średnica [mm]				
100	0,40	37,14	0,38	63,25
125	0,49	39,24	0,53	65,07
160	0,67	42,43	0,74	69,89
200	0,86	46,86	1,04	75,03
250	1,31	55,30	1,52	90,54
315	1,81	70,09	2,14	107,30
400	2,91	123,12	3,65	141,59
500	4,92	185,80	6,07	244,15

Ø 80-630

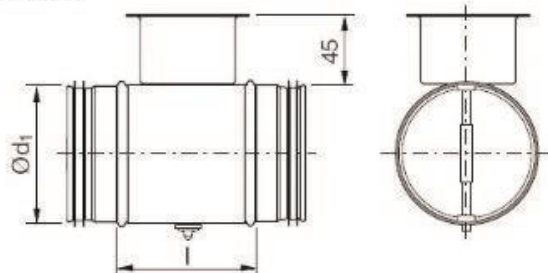

Ø 80-630

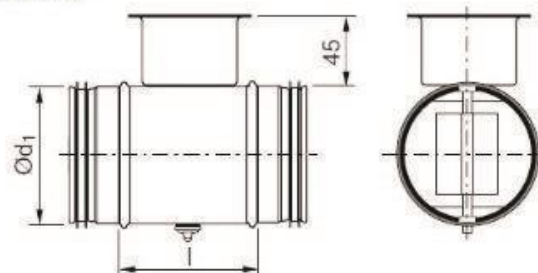

Tłumiki

				
	Średnica [mm]	L [mm]	dy [mm]	Waga m [kg]
100	600	200	1,90	305,74
125	600	225	2,70	236,33
160	600	260	3,90	265,55
200	600	300	5,60	305,74
200	900	300	8,10	387,17
250	600	350	8,30	356,63
250	900	350	11,80	453,73
315	900	415	17,00	556,76
400	900	500	27,04	757,60
500	900	600	34,56	1015,06

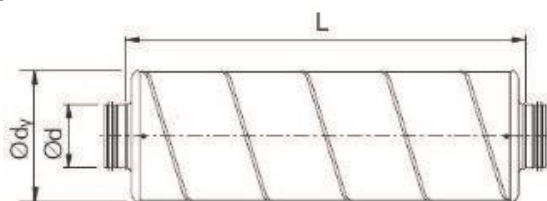

AK KLIMATYZACJE SP. Z O.O.

63-040 Nowe Miasto nad Wartą, Komorze 2C

SR Poznań Nowe Miasto i Wilda w Poznaniu IX Wydz. Gosp. KRS

Nr w KRS: 0000661997

NIP: 7861706780

REGON: 366120798

Kap. Zakł.: 60.000,00 zł